



Key Features



- 0.02 ~ 3.0 GHz
- 0.75 dB Noise Figure
- 34.0 dBm Output IP₃
- 14.0 dB ~ 23.0 dB Gain
- 21.0 dBm P_{1dB}
- 1.4:1 VSWR
- Single Power Supply
- >68 Years MTBF
- ROHS Compliant
- MLS-1 Moisture Sensitivity Level

Product Description

WHM02R integrates WanTcom proprietary low noise amplifier technologies, high frequency micro electronic assembly techniques, and high reliability designs to realize optimum low noise figure, wideband, and high performances together. With single +3.0V~+4.0V DC operation, the amplifier has optimal input and output matching in the specified frequency range at 50-Ohm impedance system. The amplifier has standard 0.12" x 0.12" x 0.055" surface mount package.

The amplifier is designed to meet the rugged standard of MIL-STD-883.

Applications

- Mobile Infrastructures
- GPS
- CATV/DBS
- Defense
- Security System
- Measurement
- Fixed Wireless



Specifications

Summary of the key electrical specifications at room temperature with configuration 30 MHz – 500 MHz LNA

Index	Testing Item	Symbol	Test Constraints	Min	Nom	Max	Unit
1	Gain	S ₂₁	30 MHz – 500 MHz		23		dB
2	Gain Variation	ΔG	30 MHz – 500 MHz		+/-0.7		dB
3	Input Return Loss	S ₁₁	30 MHz – 500 MHz	14	18		dB
4	Output Return Loss	S ₂₂	30 MHz – 500 MHz	14	18		dB
5	Reverse Isolation	S ₁₂	30 MHz – 500 MHz	20	25		dB
6	Noise Figure	NF	100 MHz – 500 MHz		0.80	1.0	dB
			30 MHz – 100 MHz			1.5	dB
7	Output Power 1dB Compression Point	P _{1dB}	30 MHz – 500 MHz	20	21		dBm
8	Output-Third-Order Interception point	IP ₃	Two-Tone, P _{out} = 0 dBm each, 1 MHz separation		34		dBm
9	Current Consumption	I _{dd}	V _{dd} = +3.50V		75		mA
10	Power Supply Voltage	V _{dd}		+3.0	+3.5	+4.0	V
11	Thermal Resistance	R _{th,c}	Junction to case			215	°C/W
12	Operating Temperature	T _o		-40		+85	°C
13	Maximum Average RF Input Power	P _{IN, MAX}	DC – 6.0 GHz			10	dBm

Absolute Maximum Ratings

Parameters	Units	Ratings
DC Power Supply Voltage	V	5.5
Drain Current	mA	120
Total Power Dissipation	mW	300
RF Input Power	dBm	10
Channel Temperature	°C	150
Storage Temperature	°C	-65 ~ 150
Operating Temperature	°C	-55 ~ +100
Thermal Resistance	°C/W	215

Operation of this device beyond any one of these parameters may cause permanent damage.

Ordering Information

Model Number	WHM02R
---------------------	--------

Waffle pack with the capacity of 100 pieces (10 x 10) is used for the packing. Contact factory for tape and reel packing option for higher volume order. Contact factory for tape and reel packing option.

Application Schematic

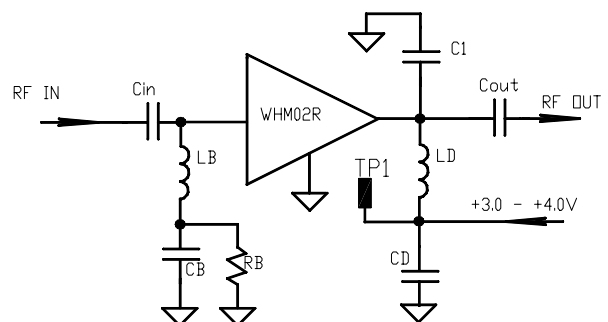

Specifications and information are subject to change without notice.



Outline

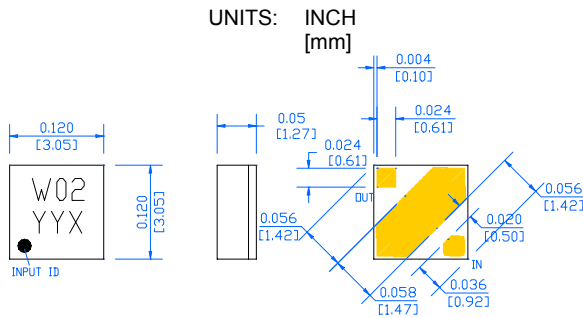

Foot Print

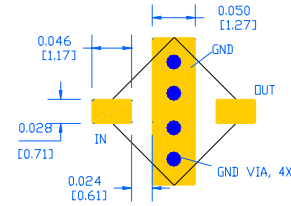

Typical Applications:

With proper setting L_B and L_D for the RF chokes in the DC bias paths, DC block capacitors C_{in} and C_{out} , and C_1 , different band high frequency low noise medium power amplifier can be formed simply using WHM02R. C_B and C_D are the de-coupling capacitors. R_B is used to set the bias current. The higher R_B value is, the larger the DC bias current will be. R_B value is in the range of 130 ~ 220 Ohm depending on the drain voltage and the drain current.

For +5.0V DC power supply instead of 3.0V to 4.0V operation, a voltage drop resistor, R_D , can be in series between the +5.0V and the amplifier. This configuration will help to reduce the sensitivity of the DC bias current to R_B value and environmental temperature variation. Different R_D values can be calculated for different drain DC bias current and voltage settings. For 3.5V drain voltage and 75 mA bias current with +5.0V power supply, the total voltage drop on R_D is 1.5V and R_D value is thus 20 Ohm. A regular 0402 size of 20 Ohm resistor does not have enough power rating for that. Instead, two 40 Ohm resistors are in parallel to share the power dissipation.

1. 30 MHz – 500 MHz wide band low noise medium power amplifier

Table 1 BOM of 30 MHz – 500 MHz LNA

Site	QTY	Description	Pkg	Mfgr Part No.	Mfgr
$C_{in}, C_{out}, C_B, C_D$	4	CAP, 0.01uF 50 V 5% X7R	0402	GRM155R71H103KA88D	Murata
C_1	1	CAP, 1.0pf 50V COG	0402	ECJ-0EC1H010C	Panasonic
L_B, L_D	2	IND, 1.0 uH	1008	PM1008-1R0K-RC	J.W. Miller
* R_B	1	RES, 169 OHM 1% 1/16W	0402	ERJ-2RKF1690X	Panasonic
IC	1	LNA	M3	WHM02R	WanTcom

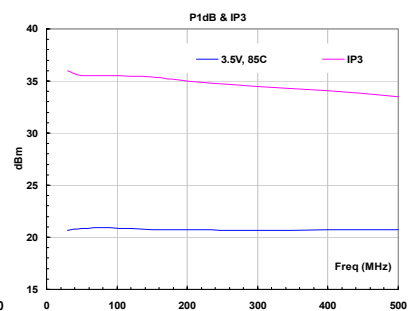
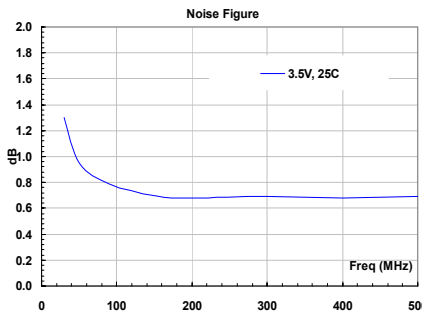
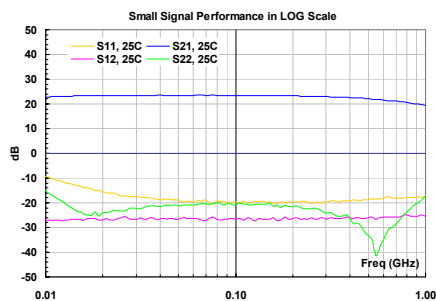

Specifications and information are subject to change without notice.



2. 0.1 GHz – 1.6 GHz wide band low noise medium power amplifier

Table 2 BOM of 0.1 GHz – 1.6 GHz LNA

Site	QTY	Description	Pkg	Mfgr Part No.	Mfgr
C _{in} , C _{out} , C _B , C _D	4	CAP, 0.01uF 50 V 5% X7R	0402	GRM155R71H103KA88D	Murata
C ₁	1	CAP, 1.0pf 50V COG	0402	ECJ-0EC1H010C	Panasonic
L _B , L _D	2	IND, 220 nH	0603	LQW18ANR27J00D	Murata
* R _B	1	RES, 169 OHM 1% 1/16W	0402	ERJ-2RKF1690X	Panasonic
IC	1	LNA	M3	WHM02R	WanTcom

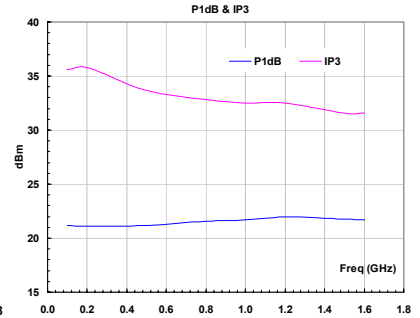
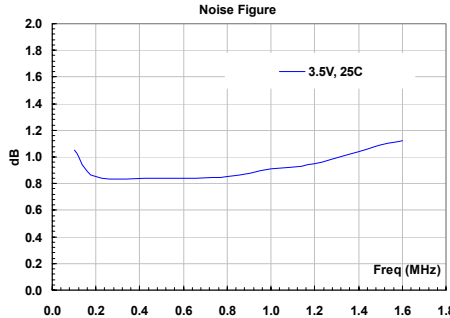
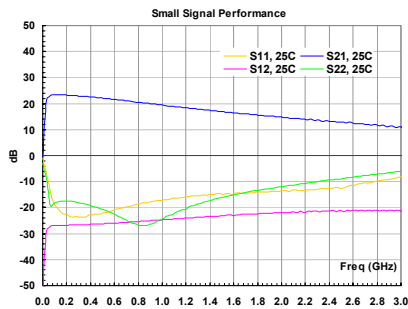

3. 1.7 GHz – 2.2 GHz wide band low noise medium power amplifier

Table 3 BOM of 1.7 GHz – 2.2 GHz LNA

Site	QTY	Description	Pkg	Mfgr Part No.	Mfgr
C _{in}	1	CAP, 5.0pF±0.25pF 50V	0402	ECJ-0EC1H050C	Panasonic
C _{out}	1	CAP, 3.0pF±0.25pF 50V	0402	ECJ-0EC1H030C	Panasonic
C _B , C _D	2	CAP, 0.01uF 50 V 5% X7R	0402	GRM155R71H103KA88D	Murata
C ₁	1	CAP, 0.3pF 50V 0402 COG	0402	GRM1555C1HR30CZ01D	Murata
L _B	1	IND, 220 nH	0603	LQW18ANR27J00D	Murata
L _D	1	IND, 15 nH SMD	0603	LQW18AN15NJ00D	Murata
* R _B	1	RES, 169 OHM 1% 1/16W	0402	ERJ-2RKF1690X	Panasonic
IC	1	LNA	M3	WHM02R	WanTcom

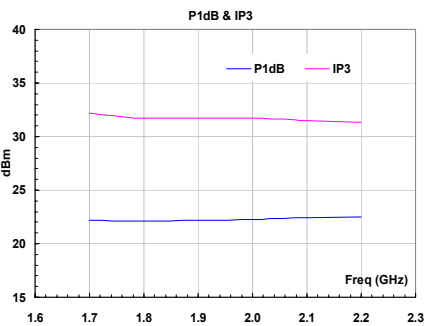
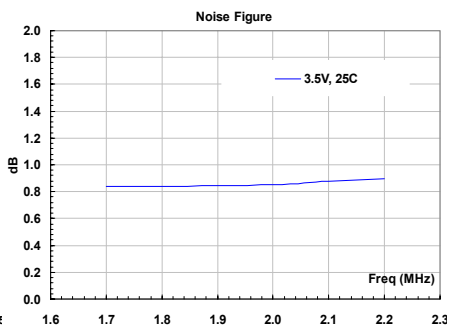
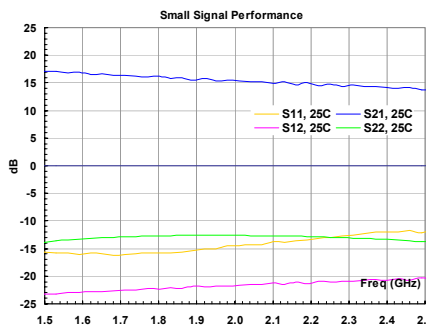

Specifications and information are subject to change without notice.



4. 2.2 GHz – 2.7 GHz wide band low noise medium power amplifier

Table 4 BOM of 2.2 GHz – 2.7 GHz LNA

Site	QTY	Description	Pkg	Mfgr Part No.	Mfgr
Cin	1	CAP, 2.0pF 50V 0402 SMD	0402	GRM1555C1H2R0BZ01E	Murata
Cout	1	CAP, 2.4pF 50V 0402 SMD	0402	GRM1555C1H2R4BZ01E	Murata
C _B , C _D	2	CAP, 0.01uF 50 V 5% X7R	0402	GRM155R71H103KA88D	Murata
C ₁	1	EMPTY	0402	---	---
L _B	1	IND, 100 nH	0603	LQW18ANR10J00D	Murata
L _D	1	IND, 10 nH SMD	0603	LQW18AN10NJ00D	Murata
* R _B	1	RES, 169 OHM 1% 1/16W	0402	ERJ-2RKF1690X	Panasonic
IC	1	LNA	M3	WHM02R	WanTcom

